

DATASHEET APSINXXG Specification v2.70

Microwave Signal Generator
9 kHz to 12, 20 and 26.5 GHz



Document size:

1 title page
19 content pages

DEFINITIONS

- The specifications in the following pages describe the warranted performance of the instrument for 23 ± 5 °C after a 30-minute warm-up period (unless otherwise stated).

Min/Max: Parameter range that is guaranteed by product design, and/or production tested. Warranted performance specifications include guard-bands to account for the expected statistical performance distribution, measurement uncertainties, and changes in performance due to environmental conditions.

Typical: Expected mean values, not warranted performance.

INTRODUCTION

- **Very compact, portable analogue signal generator models with a range from 9 kHz (with option 9K) up to 26.5 GHz.**

The APSINXXG is a series of low-noise and fast-switching microwave signal generators covering a continuous frequency ranges from as low as 100 kHz up to 12, 20, and 26 GHz, respectively, with a 0.001 Hz resolution. The APSINXXG provide an accurately levelled output power range and high spurious suppression. Advanced frequency synthesis with fractional-N divider makes for low SSB phase noise and micro-Hz resolution.

Available Options:

- **Option HP** delivers higher maximum output power to a level up to +27 dBm.
- **Option PE3** is an optional power level extension to accurately level below -90 dBm.
- **Option FS** substantially enhances the switching speed
- **Option NM** removes all built-in modulation capabilities if not needed (APSIN20G, APSIN26G only)
- **Option B3** adds an internal rechargeable battery module
- **Option 9K** low frequency extension down to 9 kHz (APSIN20G, APSIN12G only)
- **Option 1URM** modifies form-factor to a 19" rack-mountable 1HU enclosure

The standard APSINXXG includes amplitude modulation (AM), DC-coupled, low distortion wideband frequency modulation (FM), PM, FSK and PSK, frequency chirp, and fast pulse modulation with internal pulse train generator. Three internal modulations sources are available. All modulation modes of the APSINXXG can be combined. This allows the generation of complex modulation signals for modern communication and location systems. The combination of pulse modulation and FM simulates Doppler effects or chirp signals. Simultaneous AM and pulse modulation provide the types of signal occurring in pulse radar applications with rotating antenna. The combination of FM and AM can be used to check fading effects of FM receivers.

All APSINXXG allow fast analog and digital sweeps including flexible list sweeps, where frequency, power and dwell times can be set individually. A flexible triggering capability simplifies synchronization within test environments.

All APSINXXG operate with an ultra-stable temperature compensated 100 MHz reference (OCXO) to ensure minimal drift, and can be phase-locked to any stable external reference in a range from 1 to 250 MHz. Additionally, optimum phase synchronous signals can be achieved by bypassing internal and feeding a 100 MHz signal directly as reference.

The APSINXXG support various standard interfaces such as USB-TMC, LAN, and GPIB.

Applications for the APSINXXG include

- R&D low noise microwave source
- Production testing (industry-leading switching times; high dynamic range)
- Service and maintenance (battery operation)
- Signal simulation (Radar, WiMax, UWB)
- Aerospace & Defence (Pulse modulator, Chirps)

SPECIFICATIONS

PARAMETER	MIN	TYPICAL	MAX	NOTE
Frequency range	100 kHz 100 kHz 100 kHz 9 kHz		12.0 GHz 20.0 GHz 26.0 GHz	APSIN12G APSIN20G, settable to 20.5 GHz APSIN26G, settable to 30 GHz Option 9 kHz
resolution		0.001 Hz		
Phase resolution		0.1 deg		
Frequency / Amplitude settling time		200 μ s	300 μ s 30 μ s	option FS
SSB Phase noise standard				
500 MHz				
10 Hz offset		-86 dBc/Hz		
1kHz offset		-126 dBc/Hz		
100 kHz offset		-137 dBc/Hz		
4 GHz				
10 Hz offset		-68 dBc/Hz		
1kHz offset		-108 dBc/Hz		
100 kHz offset		-119 dBc/Hz		
20 GHz				
10 Hz offset		-51 dBc/Hz		
1kHz offset		- 91 dBc/Hz		
100 kHz offset		- 104 dBc/Hz		
Wideband noise		-150 dBc/ Hz		
Amplitude Noise at 10 GHz		-130 dBc/Hz -140 dBm		Pout=+10 dBm, 100 kHz offset noise floor
Output power				Check maximum output power plots on page 10
Standard				
100 kHz to fmax	-20 dBm		+15 dBm	
Option PE3/PE2 only				
100 kHz to fmax	-90 dBm		+13 dBm	
Option HP only	-20 dBm -20 dBm -20 dBm -20 dBm		+18 dBm +25 dBm +23 dBm +20 dBm	< 200 MHz 0.2 to 5.5 GHz 5.5 to 16 GHz, see plot 16- 24 GHz, see plot
Options HP and PE2	-110 dBm -110 dBm -110 dBm -110 dBm -110 dBm -110 dBm		18 dBm +22 dBm +20 dBm +18 dBm +16 dBm +14 dBm	< 200 MHz 0.2 to 10 GHz 10 to 16 GHz 16 to 20 GHz 20 to 24 GHz > 24 GHz
Options HP and PE3	-90 dBm -90 dBm -90 dBm -90 dBm -90 dBm		18 dBm +22 dBm +20 dBm +18 dBm +15 dBm	< 200 MHz 0.2 to 10 GHz 10 to 16 GHz 16 to 20 GHz 20 to 24 GHz

	-90 dBm		+12 dBm	> 24 GHz
Level resolution		0.01 dB		
Level uncertainty, ALC on		0.3 dB 0.4 dB 0.5 dB 0.5 dB 0.5 dB 0.8 dB 3.0 dB	1.0 dB 1.5 dB 1.8 dB 2.0 dB 1.5 dB 3.0 dB 1.6 dB	-15 to +15 dBm -70 dBm to -15 dBm, option PE2 < -70 dBm, f<10 GHz option PE2 < -70 dBm, f>10 GHz option PE2 -60 dBm to -15 dBm, option PE3 < -60 dBm, f<10 GHz option PE3 < -60 dBm, f>10 GHz option PE3 > 15 dBm to Pmax, option HP
Temperature effects		0.015 dB/°C		0 to 45 °C
User flatness correction		up to 2000 points		
Output impedance VSWR		50 Ω 1.5 2.0		< 20 GHz > 20 GHz
Reverse Power Protection				
DC Voltage			±15 V	
RF power			30 dBm	
Spectral purity at + 5 dBm				
Output harmonics		-40 dBc	-30 dBc	See plot
Sub-harmonics		-75 dBc -50 dBc	-65 dBc -40 dBc	< 20 GHz > 20 GHz
Non-harmonic spurious < 312 MHz > 312 to 625 MHz > 625 MHz to 1.5 GHz > 1.5 GHz to 2.5 GHz > 2.5 GHz to 5 GHz > 5 GHz to 10 GHz > 10 GHz to 20 GHz > 20 GHz		-80 dBc -75 dBc -75 dBc -70 dBc -65 dBc -60 dBc -55 dBc -50 dBc	-66 dBc -70 dBc -65 dBc -65 dBc -60 dBc -55 dBc -50 dBc -45 dBc	CW +10 dBm, > 3 kHz offset
Residual FM @ 10 GHz		15 Hz		0.3 kHz to 3 kHz, weighted (ITU-T), RMS
Residual AM @ 10 GHz		0.02%		RMS value (0.01 kHz to 15 kHz)

Sweeping Capability

Sweeps can be performed with combined internal or external AM/FM/PM/pulse modulation running. With modulation enabled, the minimum step time increases to 2 ms.

PARAMETER	MIN	TYPICAL	MAX	NOTE
Digital power / frequency / list sweeps				
Sweep type: linear, logarithmic, random				
Step time (τ_{step})	400 μ s 40 μ s		19998 s	Option FS
Dwell time (τ_{val})	10 μ s		9999 s	
Off-time (incl. transient time) (t_{off})	0		9999 s	
Transient time (τ_{inv})			270 μ s 30 μ s	Option FS
Timing delay (τ_{de})		2 to 10 μ s 50 ns		Option FS
Time resolution		0.1 μ s 5 ns		Option FS
Timing accuracy per point		3 μ s 5 ns		Option FS

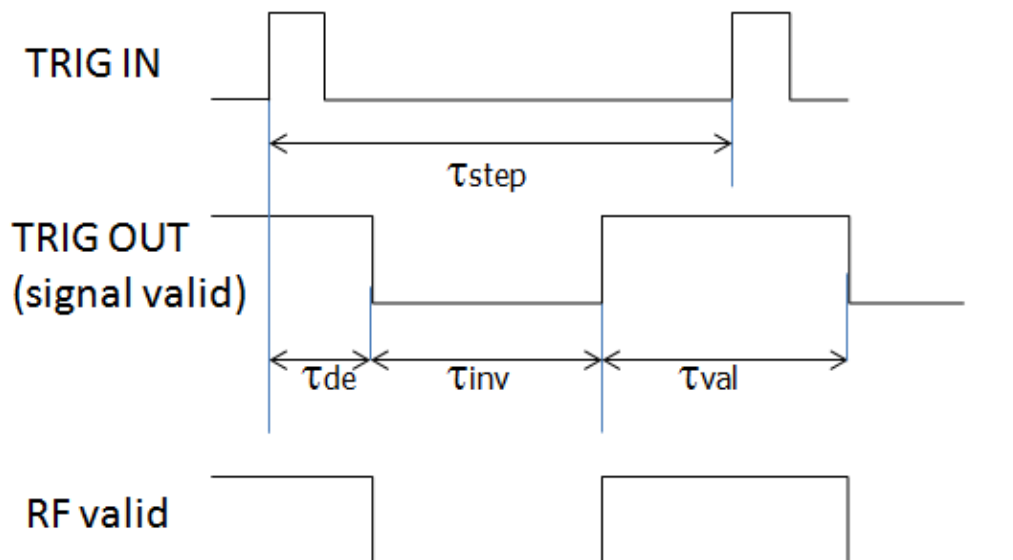

Frequency Chirps

(linear ramp, up/down)

Bandwidth	10 %			of carrier frequency
Dwell time (t_{dwell})	10 ns		10000 μ s	
Slope			100 MHz / μ s	
Number of frequencies			65'000	



Reference Frequency

REF IN input and REF OUT output are at rear panel

PARAMETER	MIN	TYPICAL	MAX	NOTE
Internal reference frequency		100 MHz		
Initial accuracy			±40 ppb	calibrated at 23 ± 3 °C at time of calibration, user adjustable
Temperature stability (0 to 50 degC)			±100 ppb	
Aging 1 st year		0.5 ppm		
Aging per day (after 30days operations)			5 ppb	
Warm-Up time		5 min		
Output of internal reference		10 MHz 10/100 MHz		
Output power		0 dBm		
Output impedance		50 Ω		
Bypass Internal reference Input	100 MHz, -5 to +10 dBm			High phase synchronous mode
Phase Lock to External Reference External Input Range	1 MHz		250 MHz	User programmable
Reference input level	-5 dBm	0 dBm	+13 dBm	
Lock Range			±1.5 ppm	
Reference input impedance		50 Ω		



Multi-Purpose Output (FUNC OUT)

Output is FUNC OUT at rear panel

PARAMETER	MIN	TYPICAL	MAX	NOTE
MULTIFUNCTION GENERATOR				
sine, triangle, square wave				
Frequency range	1 Hz 1 Hz		3 MHz 1 MHz 50 kHz	sine triangle square
Frequency resolution		0.1 Hz		
Output voltage amplitude peak-peak	10 mV	5V	2 V	Sine, triangle Square (CMOS output)
Harmonic Distortion		1%		< 100 kHz, 1 Vpp
Output impedance		50 Ω CMOS		Sine, triangle square wave
VIDEO OUTPUT (of internal pulse modulator)				
Output		CMOS		
Period	30 ns		50 s	
Pulse Width	15 ns		50 s	
RF delay		10 ns		
TRIGGER OUT Synchronization mode for multiple sources				
Modes	Trigger on sweep start Trigger on each point Signal Valid			Option FS

Trigger (TRIG IN)

Input is TRIG IN at rear panel

PARAMETER	MIN	TYPICAL	MAX	NOTE
Trigger Types	Continuous, single, gated, gated direction			
Trigger Source	RF key, external, bus (GPIB, LAN, USB)			
Trigger Modes	Continuous free run, trigger and run, reset and run			
Trigger latency		2 μ s 5 ns		Option FS
Trigger uncertainty		5 μ s 10 ns		Option FS
External Trigger delay	50 μ s 50 ns		40 s 10 s	programmable Option FS
External Delay Resolution		15 ns 10 ns		Option FS
Trigger Modulo	1		255	Execute only on Nth trigger event
Trigger Polarity	Rising, falling			
External trigger input threshold	0.85 V	0.9 V	0.95 V	TTL compatible
External trigger input voltage range	-0.5 V		+5.5 V	TTL compatible
External trigger input hysteresis		60 mV		

Trigger Output (TRIG OUT)

see Multi-Purpose Output (FUNC OUT)

Modulation Capabilities (not with option NM)

Combination of AM/PM/FM/PULSE are possible. See user manual for more details.

PARAMETER	MIN	TYPICAL	MAX	NOTE
Multifunction Generator				
sine, triangle, square wave				
Output is FUNC OUT at rear panel				
Frequency range	10 Hz 10 Hz		3 MHz 1 MHz 50 kHz	sine triangle square
Frequency resolution		0.1 Hz		
Output voltage amplitude peak-peak	10 mV	5V	2 V	Sine, triangle Square (CMOS output)
Harmonic Distortion		1%		< 100 kHz, 1 Vpp
Output impedance		50 Ω CMOS		Sine, triangle square wave
Pulse Modulation				
On/off ratio		75 dB (typical)		at +10 dBm
Repetition frequency	DC		10 MHz	
Pulse width	100ns 30 ns 500 ns		5 s 5 s	ALC hold ALC hold, options NP or FS ALC on

Pulse rise/fall time		30 ns 5 ns		<5 GHz >5 GHz
Duty cycle	0.05%		99.95%	
Pulse resolution		30 ns		
Polarity		selectable		
External input threshold	0.85 V	0.9 V	0.95 V	TTL compatible
External input voltage range	-0.5 V		+5.5 V	TTL compatible
External input hysteresis		60 mV		
Delay (to RF)		20 ns	40 ns	
Pulse Pattern Modulation				Using internal pattern generator
Pulse bit width	100 ns 30 ns 500 ns			ALC hold ALC hold, option NP or FS ALC on
Programmable pattern length	2		4192	
Duty cycle	0.05%		99.95%	
Pulse bit resolution		30 ns 5 ns		Option NP or FS
Polarity		selectable		
N-Pulse Modulation				Option FS
Period	30 ns		21 s	
N-Pulse type		1 - 4		No overlapping with other pulses
N-Pulse width (P1, P2, P3, P4 Widths) individually settable	30 ns 500 ns		21 s 21 s	ALC hold ALC on
N-Pulse delay (P1 Delay)	0 ns		21 s	
N-Pulse delay (P2, P3, P4)	Min: end of prior pulse + min off time			
N-Pulse width and delay resolution		5 ns		
N-Pulse off time	1 μ s		21 s	Determined by pulse delay and prior pulse width

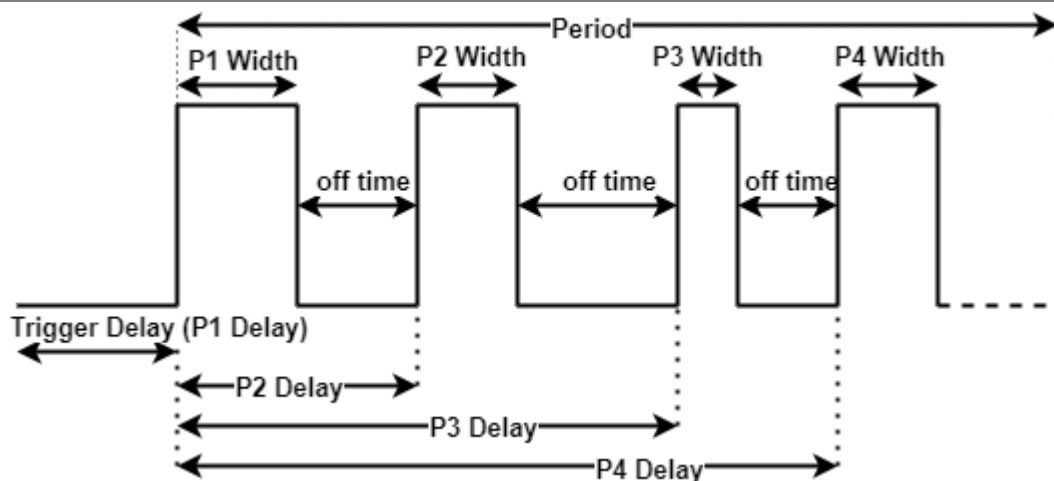

Frequency Modulation	0		0.05·f	< 0.5 GHz
Maximum Frequency deviation (peak)	0		N·200 MHz	0.5 GHz to 2.5 GHz (N=0.125) 2.5 GHz to 5 GHz (N=0.25) 5 GHz to 10 GHz (N=0.5) > 10 GHz to 20 GHz (N=1)

Deviation accuracy < 100 kHz rate > 100 kHz rate		0.5% 2%	2% 5%	
Distortion		< 1%		1 kHz rate, 50 kHz deviation
Modulation rate	DC		800 kHz	> -3dB frequency response
Modulation waveforms	Sine, triangle, FSK			
External input sensitivity AC coupled DC coupled	0 to N · 200 MHz / V 0 to N · 100 MHz / V			adjustable for ±1 V range discr. values; ±5 V range
Total harmonic distortion	< 1%			1 kHz rate & N · 1 MHz deviation
Phase Modulation				
Phase deviation (peak)	0		N·300 rad	
Modulation rate	DC		800 kHz	> -3dB frequency response Max. phase deviation degrades above 20 kHz modulation rate
Modulation waveforms	Sine, triangle, FSK			
External Input sensitivity	Settable 0.1 rad/V to 360 rad/V			
Total harmonic distortion	< 1%			1 kHz rate & N x 100 rad deviation
Amplitude Modulation				
Modulation rate	0.1 Hz		50 kHz	
Modulation waveforms	Sine, triangle, square			
Modulation depth	0%		90%	settable
Distortion (sine wave)		2%	7%	at 60% modulation depth
External Input range	0 V		5 V	to GND

PERFORMANCE CURVES

Typical performance curves Phase Noise Performance (1 Hz to 100 MHz offset) at different frequencies

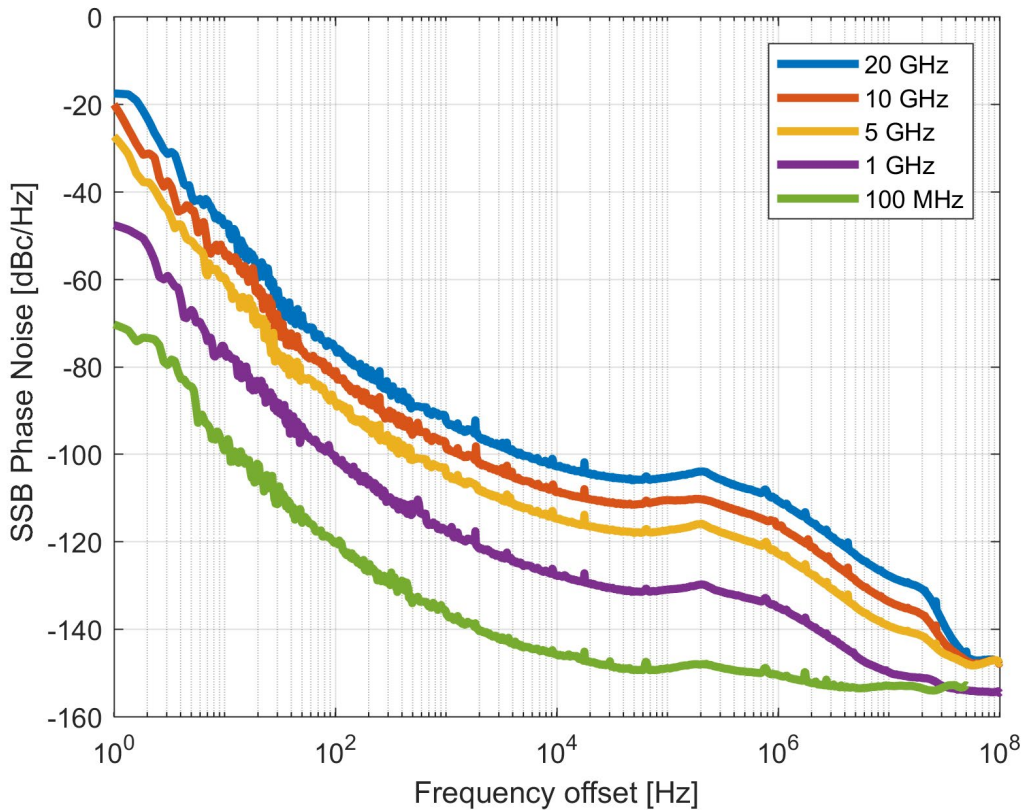

Typical Switching transient from 12 GHz to 14 GHz step

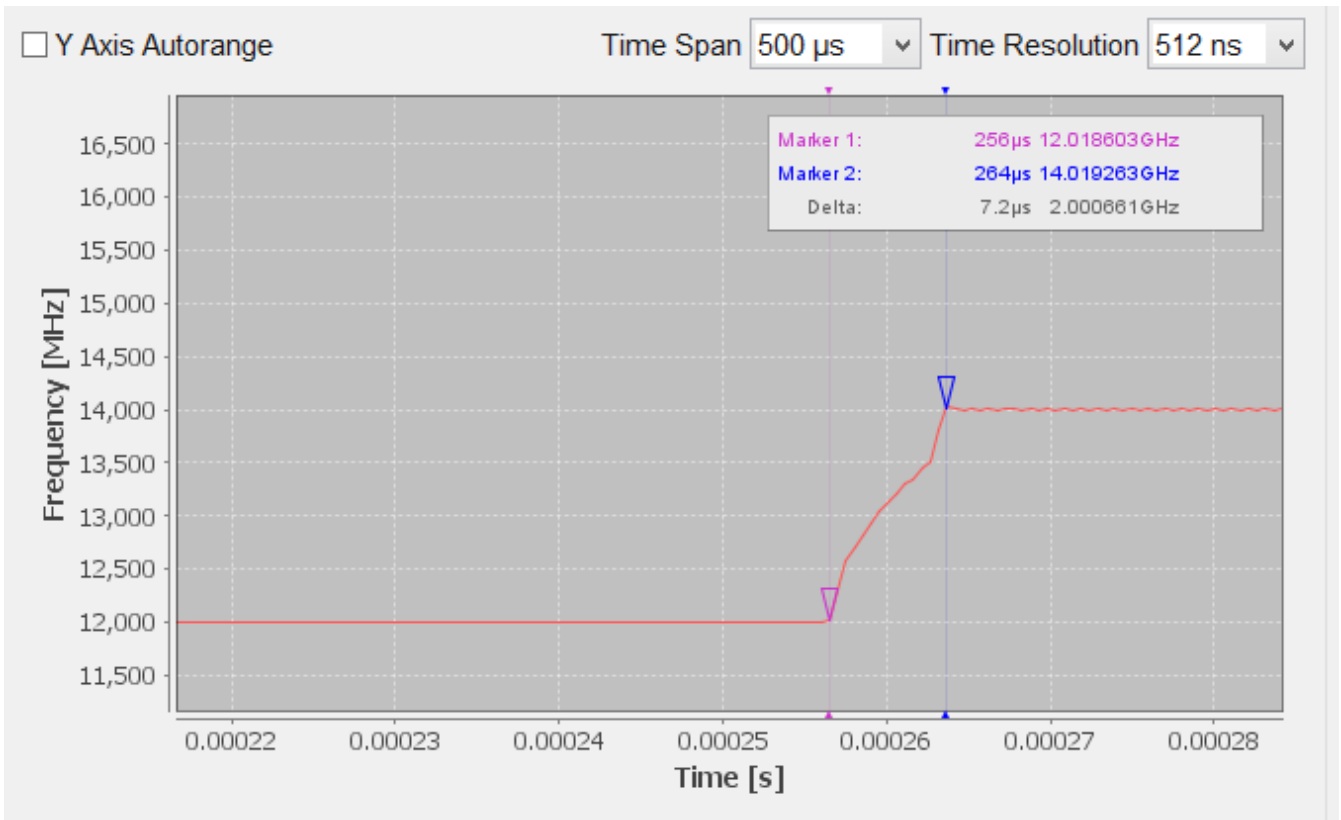

 Typical Frequency Response 0 to 20 GHz at -20, 0, and +20 dBm

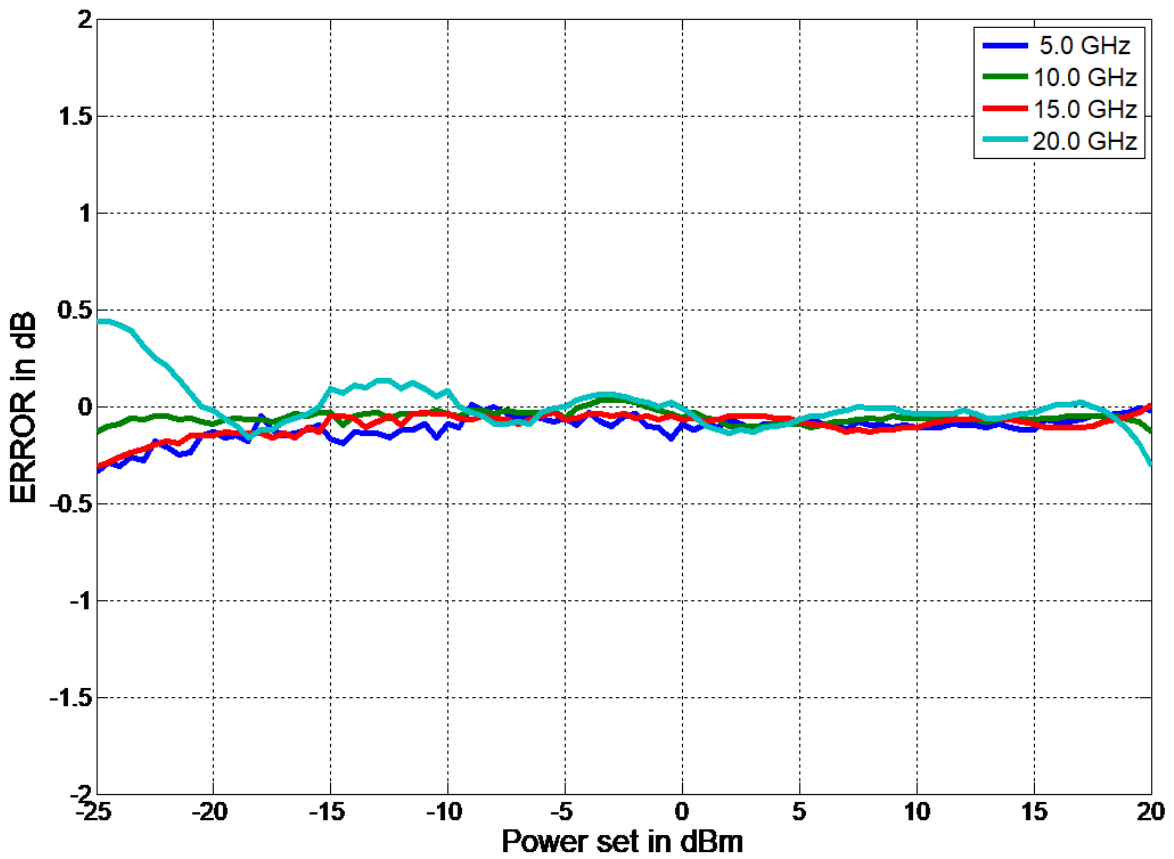
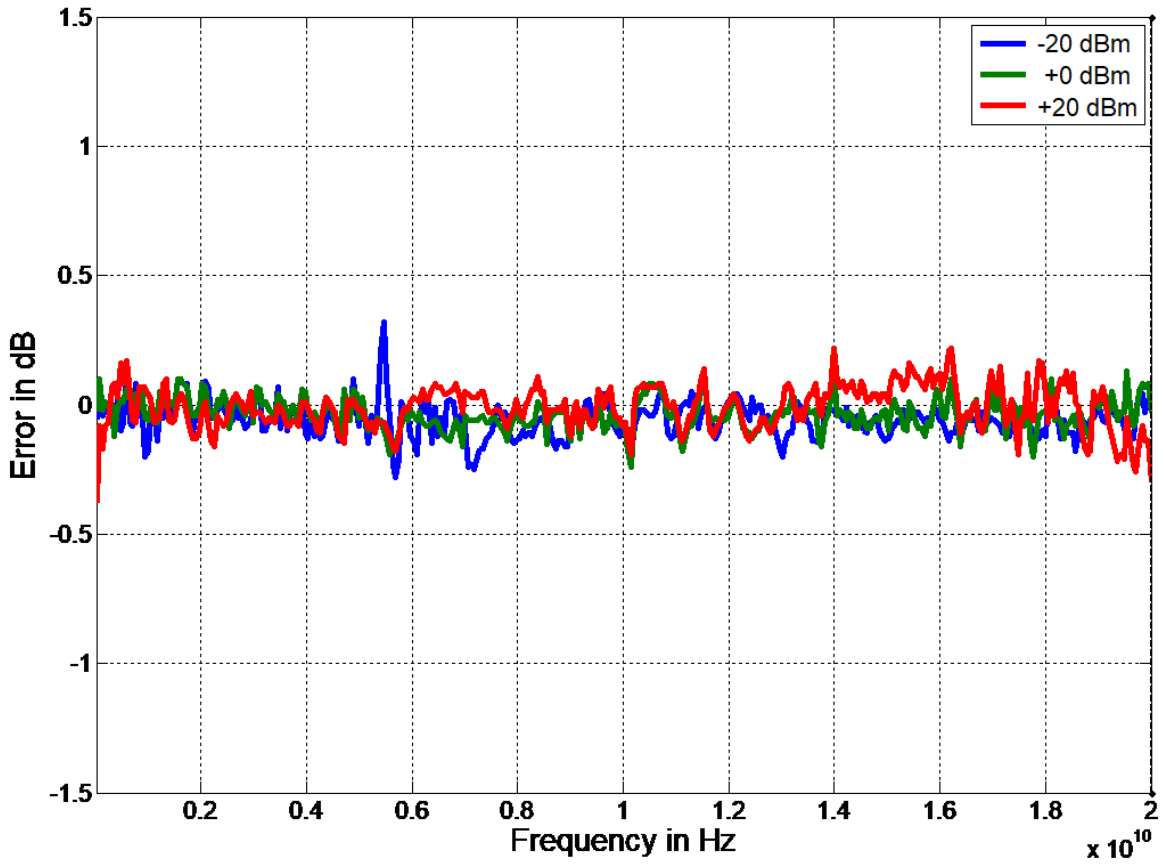

 Typical Maximum Output Power (standard)

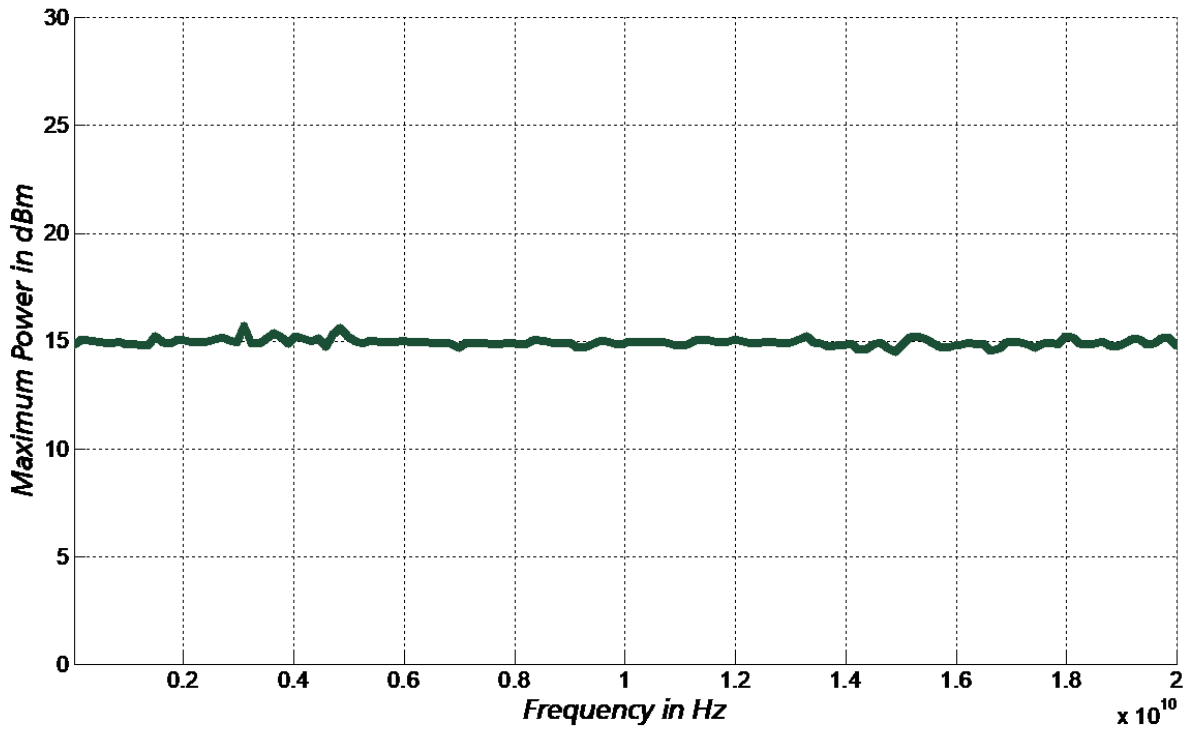

 Typical Maximum Output Power (option HP)

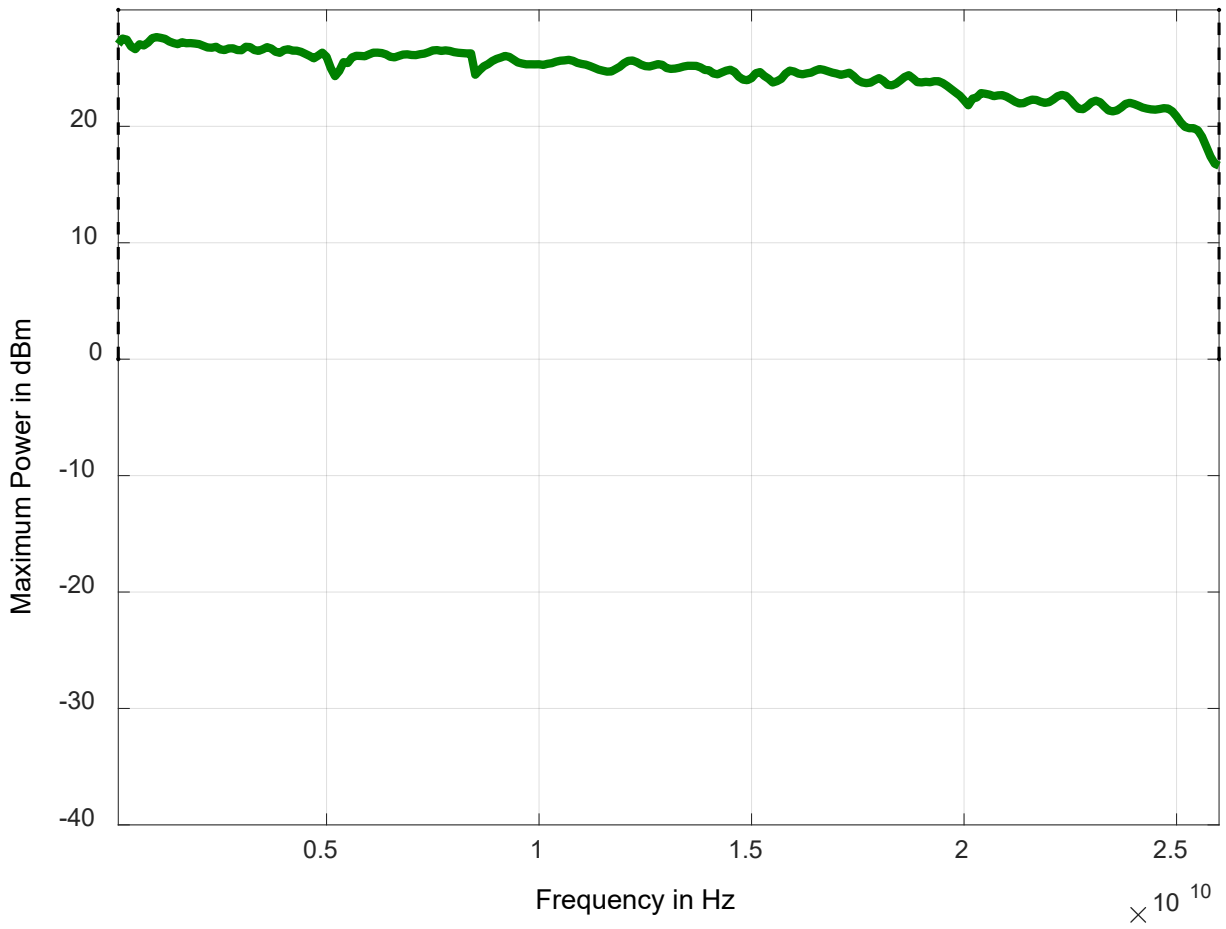

Typical Maximum Output Power (options PE3 and HP)

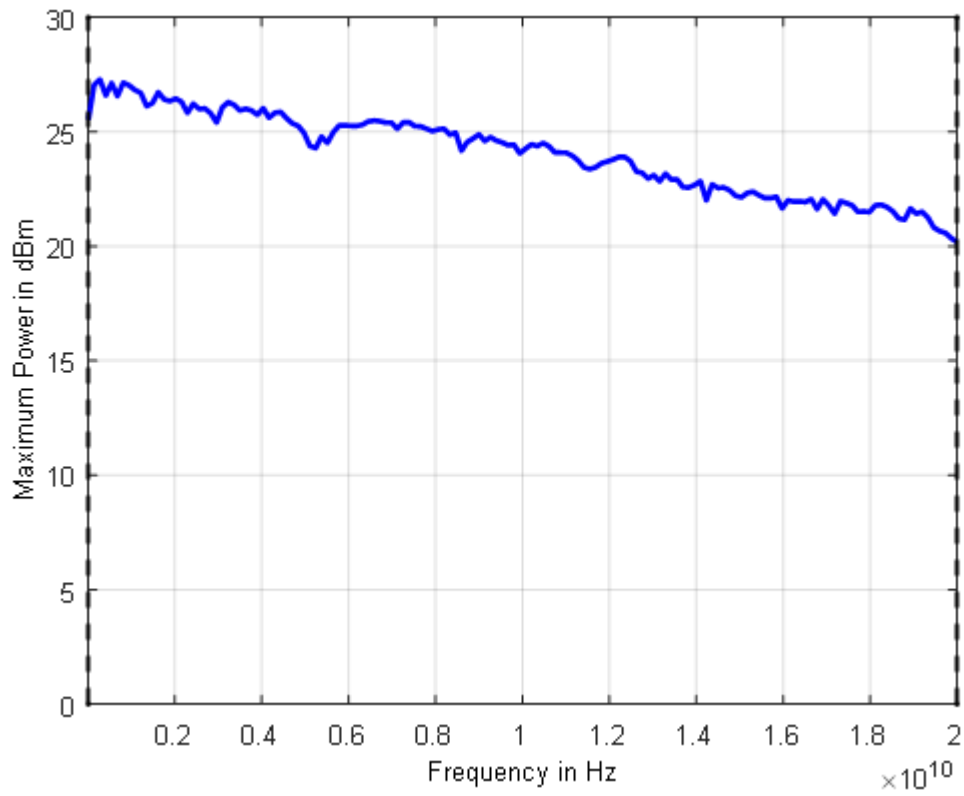

Typical Maximum Output Power from 9 kHz to 1 MHz (options 9k)

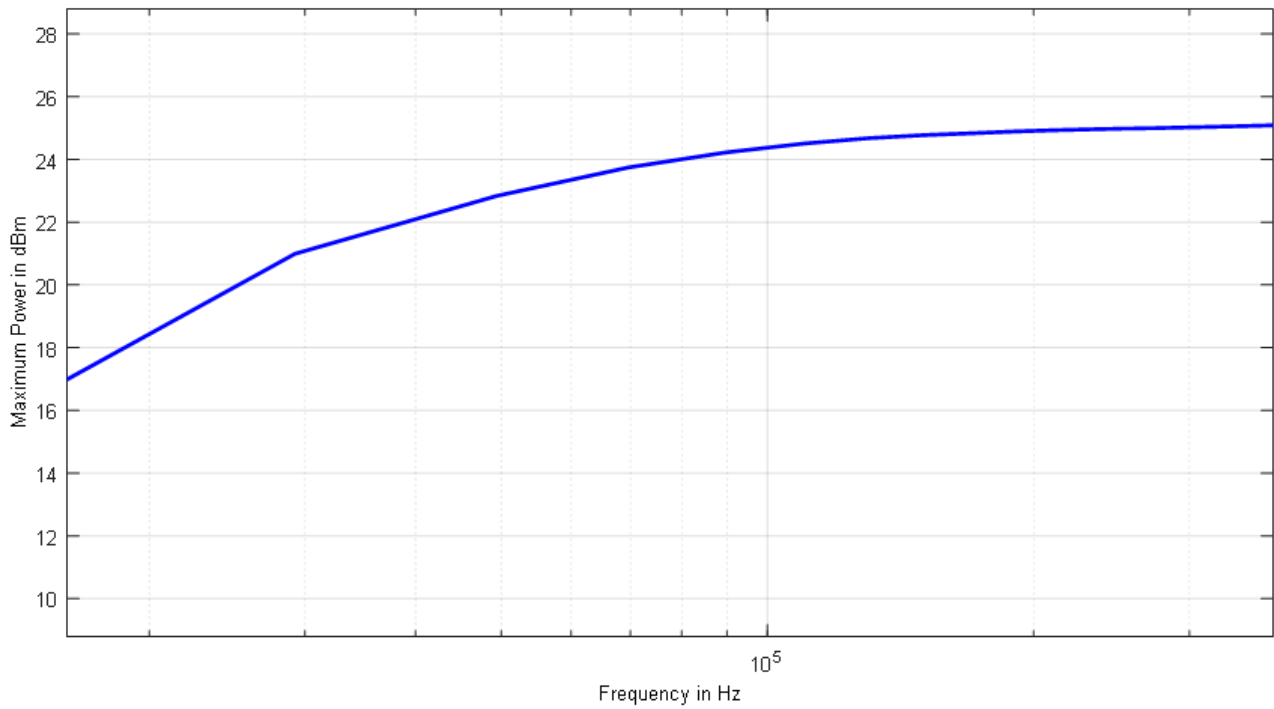

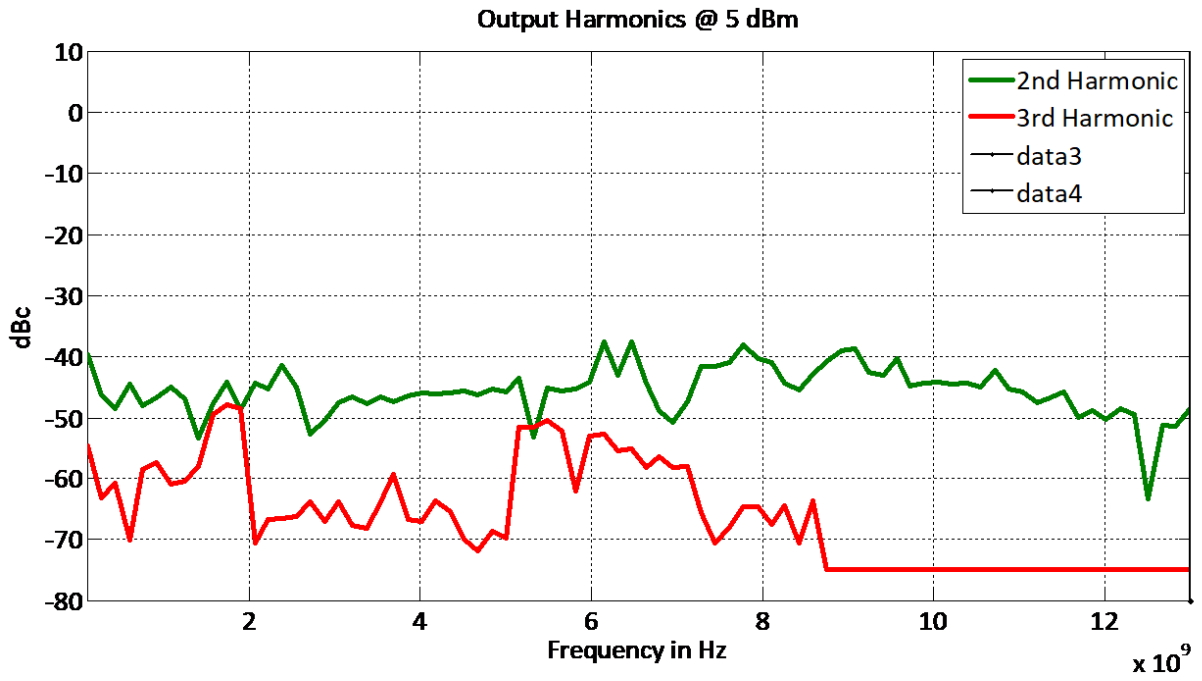

 Typical VSWR (APSIN20G)

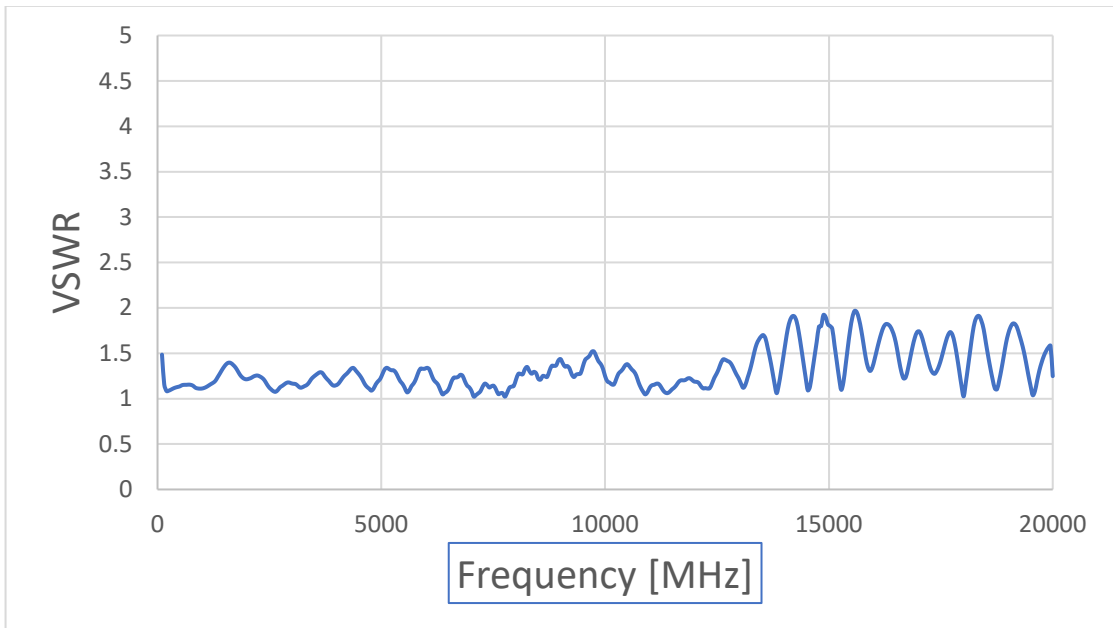



1. **Rotary Button** The rotary button is used to change the value selected on the screen.
2. **RF 50 Ω connector** This female N- type respectively SMA connector provides the output for generator signals. The impedance is 50 ohm. The reverse power damage level is +30 dBm maximum. The maximum allowed DC level is +/- 10 V. Please check the data sheets for more details.

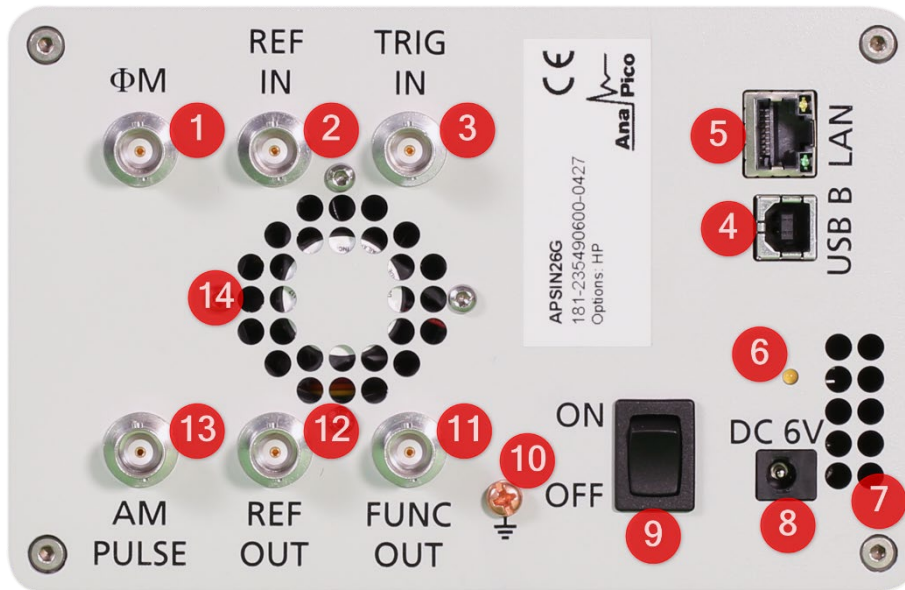

Rear



1. **ΦM** This BNC female Connector is the input for FM and PM.
2. **REF IN** This BNC female Connector is the input for the reference signal.
3. **TRIG IN** This BNC female Connector is the trigger input.
4. **USB B** The USB B connector is used to connect the device to a computer.
5. **LAN** The LAN connector is used to connect the device to a network.
6. **Battery LED** In case the device has a rechargeable battery, this LED indicates whether the battery is charged or not.
7. **Fan Holes** The air intake of the fan.
8. **Power Supply** Connect the Anapico power adaptor to this connector to supply the device with energy.
9. **ON/OFF Switch** Turns the device on or off.
10. **Ground Screw**
11. **FUNC OUT** This BNC female Connector is the output for the function signal.
12. **REF OUT** This BNC female Connector is the output for the reference signal.
13. **AM PULSE** This BNC female Connector is the input for the AM and the PULSE Modulation signal.
14. **Fan Holes** The holes by which the air is extruded.

ORDERING INFORMATION

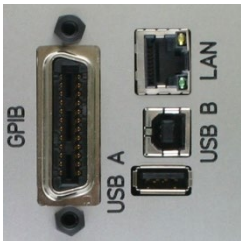

HOST MODEL	PRODUCT	DESCRIPTION
APSIN12G	APSIN12G	12 GHz MW Signal Generator
APSIN20G	APSIN20G	20 GHz MW Signal Generator
APSIN26G	APSIN26G	26 GHz MW Signal Generator
APSIN12G/20G	Option 9K	Frequency range extension to 9 kHz
APSINxxG	Option PE2	Mechanical step attenuator to -110 dBm
APSIN12G/20G	Option PE3	Mechanical step attenuator (12 & 20 GHz version) to -90 dBm
APSIN26G	Option PE3	Mechanical step attenuator (26 GHz version) to -90 dBm
APSINxxG	Option HP	Higher output power
APSINxxG	Option FS	Ultra-fast switching speed
APSINxxG	Option NP	Narrow pulse modulation
APSINxxG	Option B3*	Internal rechargeable battery module
APSINxxG	Option FLASH	MicroSD card slot for removable SD memory
APSINxxG	Option DATA	Commercial Calibration Certificate with test data
APSINxxG	Option IEC	IEC 17025 calibration with certificate
APSINxxG	Option Bag	Portable Bag
APSINxxG	Option GPIB*	GPIB interface 
APSINxxG	Option EB6	External power bank adapter cable with voltage converter for 12 to 25 V supply Required input connector: Inner / outer diameter 2.1 / 5.5 mm 
APSINxxG	Option 1URM	19" 1HU rack-mount module  Dimensions 42 mm H x 426 mm W x 460 mm L [1.7 in H x 16.8 in W x 18.1 in L]
APSINxxG	Option RM	19" 3HU rack-mount kit
APSINxxG	Option REAR	Move output to rear panel
APSIN20G /26G	Option NM	Remove modulation
APSINxxG	Option OEM	OEM package
APSINxxG	Option WE	One year warranty extension (standard: 2 years)
APSINxxG	Option ReCal	Recalibration with test data (recommended: 2 years interval)
APSINxxG	Option Retrofit	Applies when options are back-ordered

GENERAL CHARACTERISTICS

Remote programming interfaces

Ethernet 100BaseT LAN interface,
USB 2.0 host & device
GPIB (IEEE-488.2,1987) with listen and talk (optional)
Control language SCPI Version 1999.0

Power requirements 6.25 ± 0.2 VDC; 20 W maximum

Main adapter supplied: 100-240 VAC in/ 6 V 6.0 A DC out

Environmental (Levels similar to MIL-PRF-28800F Class 3/4)

Environmental stress Samples of this product have been type tested to be robust against the environmental stresses of storage, transportation, and end-use; those stresses to temperature, humidity, shock, vibration, altitude, and power line conditions.

Operating temperature range 0 to 40 °C

Storage temperature range -40 to 70 °C

Operating and storage altitude up to 15,000 feet (4600 m)



EMC complies and EMC regulations and directives for emission and immunity to interference (EN 61326-1 Industrial, EN/IEC 61326-2-1)

Safety complies with applicable Safety regulation in line with IEC/EN 61010-1

Weight ≤ 2.5 kg (6 lbs) net, ≤ 4 kg (8 lb.) shipping

Dimensions

116.9 mm H x 173.6 mm W x 261.7 mm L (incl. connectors)
[4.60 in H x 6.83 in W x 10.30 in L]

Recommended calibration cycle 24 months



Document History

Version	Date	Author	Notes
V10	2010-06-01	jk	first release
V11	2010-08-30	jk	added specs for VSWR, AM noise, residual
V13	2010-10-15	jk	power, frequency range, modulation specs updated
V14	2011-04-28	jk	Frequency and power range, Output connector, added phase noise plot
V160	2013-08-26	db	Modified sweep timing specs, added max power measurement plots
V20	2014-07-30	jk	Combined APSIN20G and option HP
V21	2014-11-10	jk	Added pulse pattern specs
V22	2014-12-10	jk	Unified data sheet for APSINXXG
V23	2015-1-15	jk	Added max. power plots
V240	2015-10-29	jk	Clarified switching speed, Phase noise revised
V241	2015-12-18	jk	Power level accuracy refined
V241	2016-01-12	jk	Refined spurious specs
V245	2016-03-04	jk	Included ALC temp effects, renewed phase noise plots
V246	2016-04-04	jk	Power level accuracy option deppendant
V247	2016-06-21	jk	Internal pulse modulation max pulse width corrected
V248	2016-07-15	jk	Power level accuracy for PE3 option
V249	2016-09-15	jk	Option LN data refined
V250	2016-11-15	jk	Option LN data refined
V251	2017-03-30	jk	VSWR adjusted
V252	2017-05-30	jk	New front / rear plots
V253	2017-07-10	jk	Max power specifications refined for low frequency range
V254	2017-09-7	jk	Refined FM sepcs
V255	2018-04-7	jk	Option 9k added, option LN removed
V256	2018-05-7	jk	Option TP added, plots renewed
V257	2018-08-30	jk	Option LH added
V258	2019-01-30	mm	Dimension up-date
V259	2019-03-12	mm	New datasheet layout
V260	2019-12-10	jk	Max power specification refined, VSWR plot
V261	2020-08-10	jk	Minor fixes
V262	2020-11-12	ee	Option TP removed, product images updated
V263	2021-01-30	Jk	Pulse parameter specs revised
	2021-02-10	ee	Added image and dimensions to Option LH in Ordering Information
V264	2021-02-25	db	Pulse and trigger input electrical specifications
V265	2021-05-10	ee	Added option EB6
V266	2021-07-15	jk	Minor fixes
V267	2021-11-19	ee, db	Removed Option LH, updated option FS pulse width resolution
V268	2022-02-03	dbe	Added N-Pulse Modulation
V269	2022-02-11	jk	Added option NP
V270	2022-03-15	db	Added AM input voltage range

AnaPico of Switzerland

Europa-Strasse 9
8152 Glattbrugg
Switzerland

Phone +41 44 440 00 50
Email sales@anapico.com

www.anapico.com
www.anapico.com/downloads/

