



Understanding Star Switching

the star of the switching is often overlooked

Written by: Walt Strickler

V.P. of Business Development, Switching

Giga-tronics Incorporated

Published: November 2009

Revision: A

The  of Switching is often overlooked!

When implemented properly, you can have the ultimate flexibility in your switching system, even when your pin-out is already fixed!

Understanding the Impact of Switching

Switching is probably the most overlooked and undervalued part of a test system design. Great attention is spent selecting the measurement and stimulus instruments. But more often than not, the signal switching solution does not complement the instruments. It doesn't matter how accurate the instruments are if the signals pass through a poor switch to get to them. Engineers are familiar with test instruments because they have used them during their school years and at work in the lab and on the bench testing products or debugging new designs. So it's easy for them to select instruments for an automated test system. On the other hand, the engineers probably did not use switching in day-to-day testing and only consider switching a minor component in an automated test system.

Choosing a switching system can be difficult because engineers often have little experience in test "system" design. They are accustomed to moving test probes by hand, carefully connecting the probes and ground clips to the unit under test (UUT), and/or attaching cabling with the proper torque to ensure a quality connection. A good automated test system design should select the switching that best emulates what the engineer would have done when connecting instruments manually.

Common Switching Problems

A common problem when utilizing switching is a lack of appreciation for the potential effects of adding significant lengths of transmission lines (e.g., cable). When making a single measurement or set of measurements with an instrument, engineers often have the test equipment and the UUT close together, if for nothing more than convenience. In an automated test system, multiple sets of measurements are made with multiple combinations of instruments. Physical space limitations dictate that the equipment and UUT are placed further from each other. Moreover, the addition of a switching system adds a whole other set of cabling because now the user cannot go directly from instrumentation to UUT, not to mention the length of transmission line contained within the switch system itself.

Ideally, all transmission line is lossless, has exactly the right impedance, bandwidth is unlimited and parasitics are non-existent. In practice, there are many limitations that prevent ideal performance. Transmission lines have insertion loss and impedance mismatch occurs at every adapter and connector interface, including the switch contacts. Parasitic capacitance and inductance can limit the bandwidth and induce cross-talk between signals, as well as enable coupling of noise and interference. Grounding schemes and attention to transmission line stubs play a key role as well.

Consider this example. Figure 1 shows a digital signal going directly from a signal generator to an oscilloscope. Figure 2 shows the same signal with a 3' ground wire (such as a ground wire used outside of the switch module). The waveform has significantly degraded. As shown in Figure 3, if the ground is forgotten or omitted altogether for fear of ground loops, the signal loses its squared corners altogether. If the signal is used as part of a clocking scheme, the timing of the system may be dramatically affected if not lost.

The  of Switching is often overlooked!

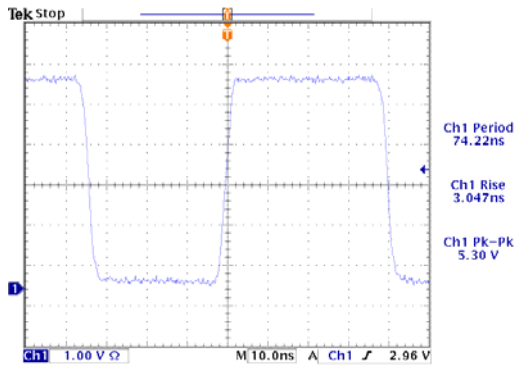

Figure 1



Figure 2

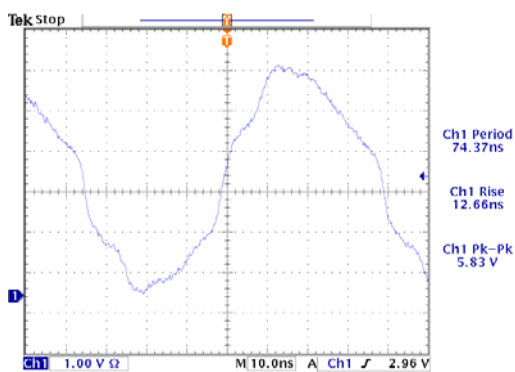

Figure 3

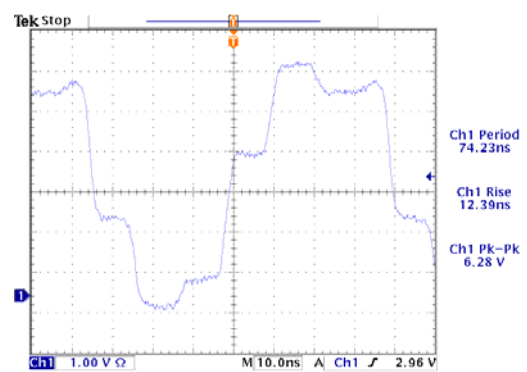

Figure 4

Many times a signal must pass through multiple switches to get to an instrument. In those cases, special consideration must be given to transmission line stubs of the non-closed switches. If the impedance and length of those stubs are not well controlled, significant degradation can occur. These stubs can become antennas or resonators. Figure 4 shows the digital signal from the example after having passed through multiple switches.

Another very common problem encountered selecting or designing switching systems can occur when an engineer does not ensure the switch has adequate bandwidth. Often engineers get high-end signal generators and spectrum analyzers or oscilloscopes with wide bandwidths and then don't give ample attention to the switching system. In those cases, the extra money for high performance instrumentation is wasted as the switch band limits the signal before it ever gets to the UUT or measurement equipment.

For example, a well known pace-maker manufacturer paid nearly \$100,000 for their test system, represented in Figure 5. With human life in the balance, no expense was spared. Then the switching system was purchased. As is often the case, little attention was paid to ensure the switch had adequate performance and would not affect the test results. Since an average heart beats around 70 times per minute and a pacemaker with defibrillator only puts out a moderate amplitude voltage signal, the customer engineer selected a low cost switching system with 5 MHz bandwidth. The bandwidth was thought to be well beyond the 70 beats per minute (bpm).

The test engineer soon found that he was receiving an unexpected response from the device or the device wasn't receiving the signal at all. This was a very different result than when he was connecting the instrumentation and UUT directly. The engineer had forgotten or did not realize that not only is the fundamental frequency of signal important to bandwidth, but the shape of the signal is important as well.

The  of Switching is often overlooked!

A narrow time pulse is comprised of a wide range of frequencies. A good rule of thumb is that the bandwidth (BW) of a signal is approximately $BW = 0.35/t_r$, where t_r is the rise time of the signal. The rise time of the defibrillator signal was approximately 20 ns, much faster than the 70 bpm of the fundamental signal. A 20 ns rise time signal requires a bandwidth of 17 MHz to keep its shape. As it turns out, the switching system that he thought well exceed his requirements was in fact inadequate. Not only was the bandwidth too low (5 MHz vs. 17 MHz requirement), but it also suffered from high levels of noise and crosstalk. All three were likely to have been significantly affected by insufficient attention to transmission line lengths, stubs, etc.

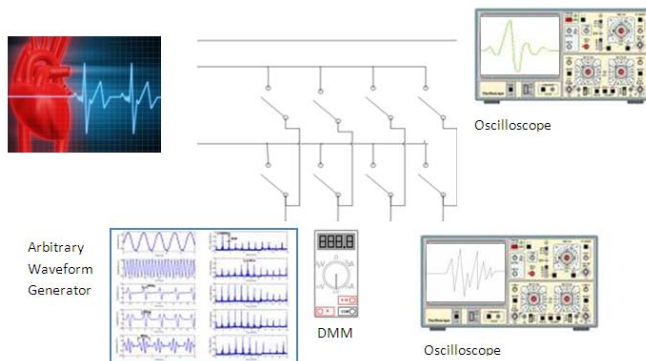

Figure 5

Sometimes automated test systems have a very large number of signals that need to be switched to and from the UUT and instrumentation. However, there may be a limit on the number of signals that can be switched due to space limitations, interconnection difficulties, and mass cabling restraints. With today's advances in microelectronics, switch vendors are offering more and more dense switching modules. However, interconnecting modules to form larger switching systems is still quite a challenge. Interconnecting transmission lines that are not designed for optimal line lengths to minimize stub effects or are not carefully controlled to optimize match as part of the initial switching system will be problematic. Even with more dense switching modules available and carefully selected interconnections, sometimes there may be physical restrictions on the space available for switching. In those cases, it would be highly advantageous to have a switching system with the flexibility to dynamically change the configuration of inputs and outputs and port to port connections. There is more on this topic later in this article.

Best Practices

After decades of experience in designing switching systems, engineers like industry guru Jeffrey Lum at Giga-tronics have developed some best practices to avoid or eliminate the common problems discussed above. These best practices include the separation of grounds and ground planes and an uncompromising focus on signal shielding and signal isolation.

For example, Figure 6 below shows what appears to be a typical switching module. However, careful attention has been given to separate the grounds for the chassis, analog circuitry, and digital circuitry, as highlighted in Figure 7. In addition, control, power, and signal lines have been isolated from each other by placing them on separate printed circuit board (PCB layers) interwoven between ground planes. A third step is carrying the shield between instrumentation and UUT through the switch.

The end result is that the noise and crosstalk within a switching system can be minimized, making it more likely to be transparent to the tests and measurements being made. Lower crosstalk and noise also have a direct impact on the bandwidth of the switching system.

The  of Switching is often overlooked!

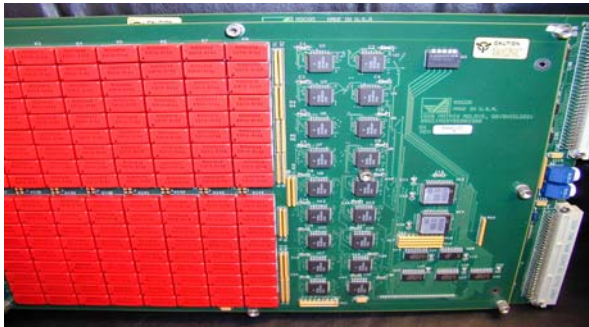

Figure 6

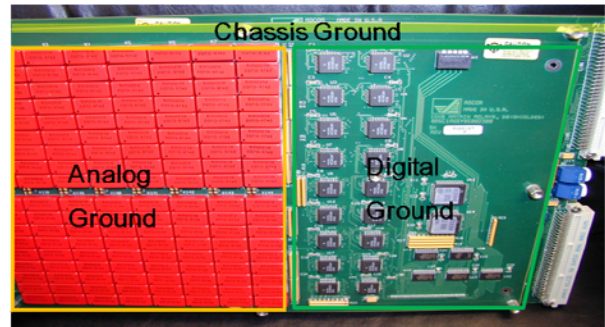

Figure 7

While few switching system designers pay such close attention to grounding schemes and the shielding and isolation, even fewer employ the best practice of considering the basics of transmission line theory. For example, in higher frequency switching systems, care is often given to ensure the impedance of the signal path through the switch is 50 ohms. In lower frequency switching, care is often given to matching signal path impedance. In both cases, the effects of the stubs created from the paths not part of the signal path are often overlooked. Matching impedances insures maximum signal integrity by minimizing reflections. Elimination, minimization, or at least careful control of stubs is critical to maximum performance from a switching system.

This approach to signal path extends beyond the switch card. Some switching system providers integrate a backplane into the system. The backplane allows careful controlled transmission line interconnections between switch modules, as opposed to the possibility of a less experienced engineer interconnecting in a manner that would significantly degrade the switching system performance. Figure 8 shows a switching system that allows up to 12 switch modules to interconnect through a 500 MHz bandwidth, well-controlled, analog backplane.



Figure 8

The result of implementing the best practices associated with separation of ground planes, careful attention to isolation and shielding, and a focus on transmission line theory enables designers to develop switching systems with bandwidths typically 5 to 10 times greater, as well as the ability to switch lower-level signals in the presence of stronger signals and much better noise immunity than the majority of commercial switching systems available today.

The Often Overlooked Star Switch

Most switch designers and users are familiar with the traditional switch topologies. They include the building blocks like Form A, Form B, or Form C switches, and SPST, SPDT, DPDT switches, multi-throw

The  of Switching is often overlooked!

switches (SPnT), and grouping of switches to form a tree, multiplexer, or matrix. However, there is one topology that is not well known or often overlooked that can provide a switching system with many advantages, the Star switch.

A Star switch is similar to a multi-throw switch without the pole or common, as shown in Figures 9 and 10. The main difference is that with a multi-throw switch, signals can only be routed between the common and one of the throws (positions A to D). In a Star switch, the signal can be routed from any position to any other position. In the SP4T and 4-position Star switch examples, the SP4T has 4 possible signal paths. So if a switching system was limited to using 4 pins (A to D), the Star switch would allow 6 possible signal paths (50% more) and paths between pins that were not possible with the SP4T.

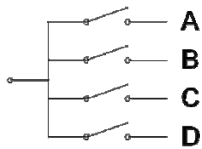

Figure 9

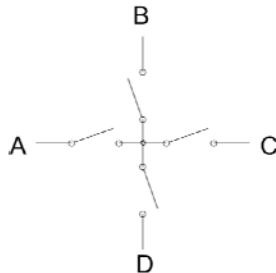

Figure 10

Beyond additional flexibility, the Star switch also has a performance advantage. Without a common, the switch is more balanced. All of the transmission line lengths are equal and stubs are shorter allowing better impedance matching and less opportunity for noise coupling through them. For example, Figure 11 shows a physical implementation of a 4-position Star switch.

To give an example of how well balanced a Star switch is, a signal with a 2 ns rise-time is connected to the common node of the 4-pole switch and connected to the output of one position. To measure the length of the path from common to output position, an oscilloscope is used to measure the propagation delay. A signal has a delay of about 1 ns per 8 inches.

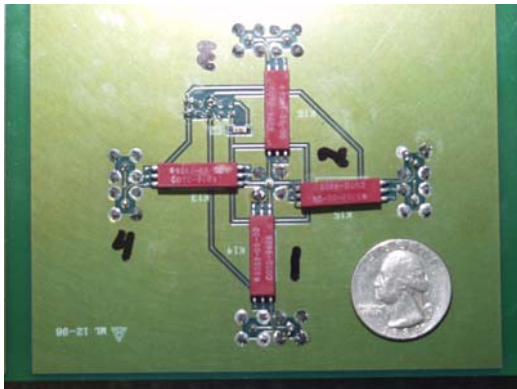

Figure 11

Figure 12 shows the propagation delay between the center of the Star switch and position #1 is 226 picoseconds. Figure 13 shows the propagation delay between the center of the Star switch and position #2 is 208 picoseconds. The resultant phase difference is 18 picoseconds. When implemented properly, the Star switch can provide the ultimate flexibility and performance in a switching system – even when the pin-out is already fixed!

The  of Switching is often overlooked!

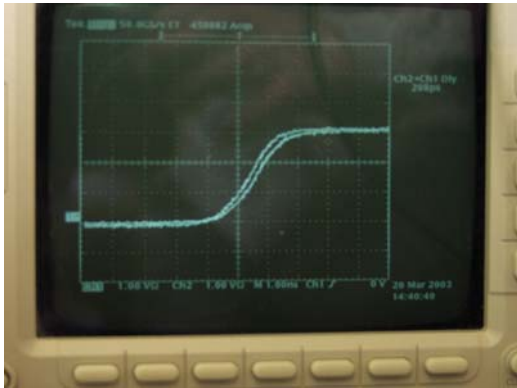

Figure 12

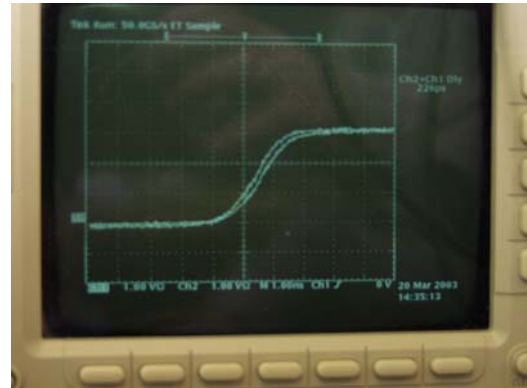

Figure 13

Many military/aerospace switching systems were design decades ago. They commonly use a form of mass interconnection to enable system resources (instrumentation, digital I/O, etc.) to interact with the UUT. These are commonly referred to as a “receiver mechanism”. A common connection type is a pin coupled with a mating connector, so the assignment of connection on the receiver mechanism is often called the “pin-out”. To ensure the interface with the UUT is consistent, the pin-out is usually fixed with all connections assigned for a particular purpose and with a particular performance (bandwidth, power capability, etc.). The testing and control of a UUT today requires much high bandwidths than they did decades ago. For example, many military/aerospace switching systems had less than 100 MHz of bandwidth, yet newer technology like low voltage differential signaling require bandwidths in excess of 500 MHz. It is a very daunting and expensive task to swap out all of the switching systems and the interface to the UUTs. By utilizing a Star switch in the switching system, not only is there much more flexibility in the interaction of system resources and UUT, but also higher performance can be attained. The pin-out can go from being fixed to being able to be dynamically reconfigured to meet both present and future requirements. In addition, the higher performance of the Star switch enables the utilization of legacy system resources while providing adaptability to future higher bandwidth or higher speed requirements.

Figure 14 (below) illustrates the flexibility and efficiency of using a Star switch architecture. In the initial design, the receiver mechanism (shown in grey) had a fixed pin-out, dedicating pins to specific 50 ohm resources, digital oscilloscopes (DSO), a digital multi-meter (DMM), etc. The switching system used nearly 30 multi-throw switches. By utilizing just 12 Star switches, the pin-out can be reconfigured to enable the receiver mechanism to interface with any of number of 50 ohm resources (like ARBs, counters, pulse generators, and signal generators), or connect to a digitizer or DMM, or route high-speed digital signals. In addition, the Star switch enables the user to disconnect unwanted paths. A very complex switch solution is achieved by using simple Star switches as its core. Figure 15 shows the entire test system with the UUT and test instrumentation interconnecting through the receiver mechanism and switching system.

The  of Switching is often overlooked!

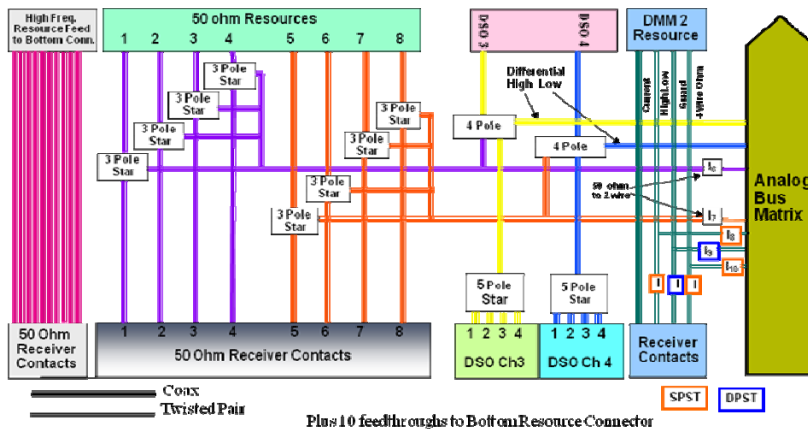

Figure 14

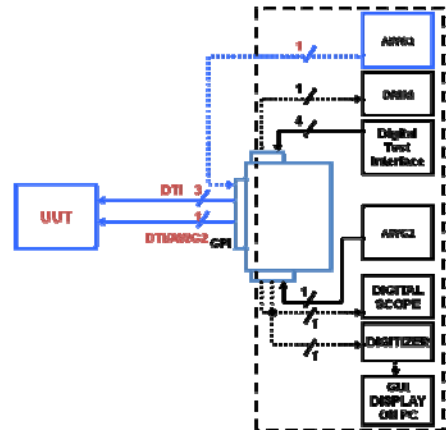

Figure 15

Conclusion

The importance of switching in an automated test system is often underappreciated. Since the switching system sits between a UUT and the test instrumentation, poor switch performance will dictate the performance of the test system despite well designed products and expensive, high-end test equipment. Common problems with ground loops and bandwidth limitation can be minimized or avoided by taking advantage of the best practices derived through decades of switching system design experience. Separating grounds and ground planes as well as employing sound transmission line theory can produce switching systems with far greater bandwidth and isolation and far less crosstalk. Taking one step further, utilization of the often overlooked Star switch will yield the ultimate flexibility in your switching system, even when your pin-out is already fixed. If you don't have the time or expertise to take advantage of these switching system tips, contact an experienced switching solution provider. Why struggle?